

.AN ORGANIC DESIGN
WITH COLOR -
SETTING NEW TRENDS
INTO EXHIBITION DESIGN

exhibition systems
software and service

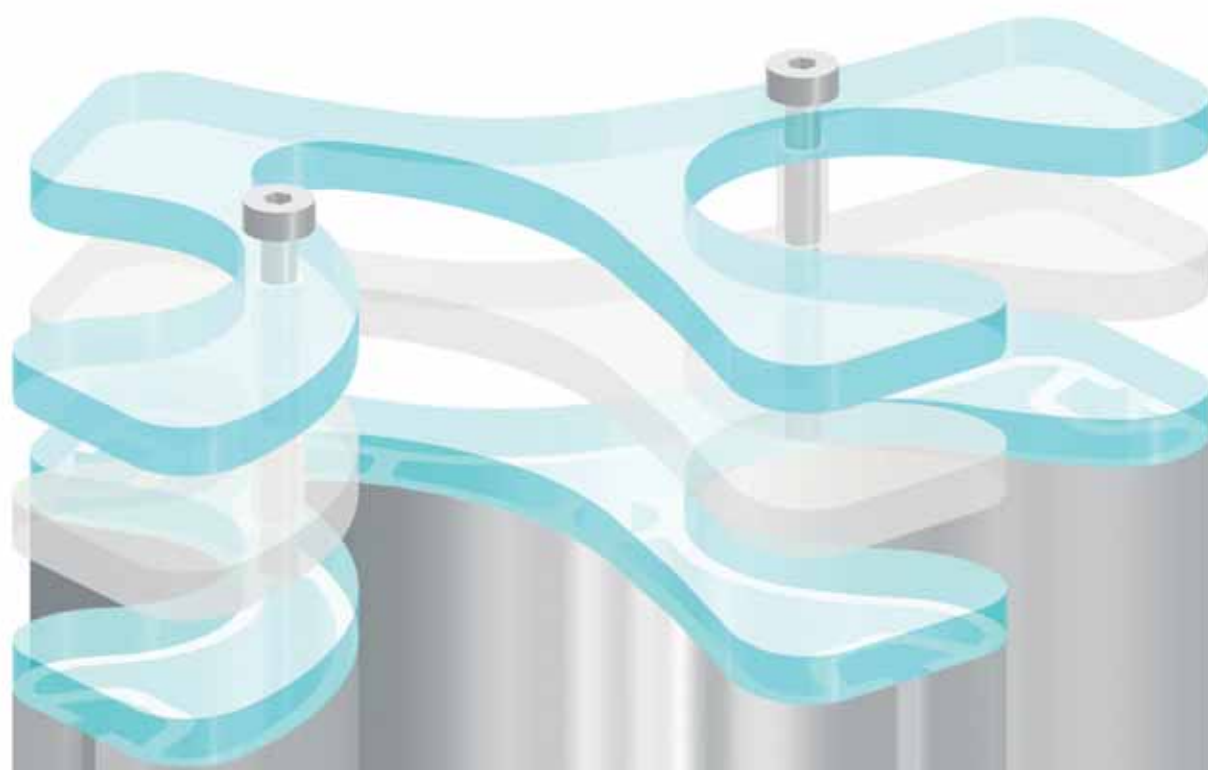

THE
WORLD
OF
SYSTEMS

OCTANORM 

UPRIGHT EXTRUSION



Aluminium Anodized or Ral Powder Coated W: 130mm 3.64 Kg/m	6200mm cut to length	VA 4020
	1005mm tooled both ends	VA 4021
	1240mm - " - " -	VA 4022
	2010mm - " - " -	VA 4023

END PLATE

VA 1220



Steel
Grey powder coated RAL 9006,
incl. fastening kit for 1-2 stacked plates
H: 5mm
0.13 Kg

END PLATE

VA 1221



Acrylic
Orange, 5130 R/R double satin
incl. fastening kit for 1-2 stacked plates
H: 5mm
0.04 Kg

END PLATE

VA 1222



Acrylic
Turquoise, 2040 R/R double satin
incl. fastening kit for 1-2 stacked plates
H: 5mm
0.04 Kg

END PLATE

VA 1223



Acrylic
Opaque, 0000 R/R double satin
incl. fastening kit for 1-2 stacked plates
H: 5mm
0.04 Kg

CONNECTING PART

VA 1229



Steel, galvanised
H: 105mm, 5mm visible
0.43 Kg



▼ **TOOLED** = Threaded for M10 bolt and deburred

ORGANIC PRODUCT LINE
EXTRUSION VA 4020

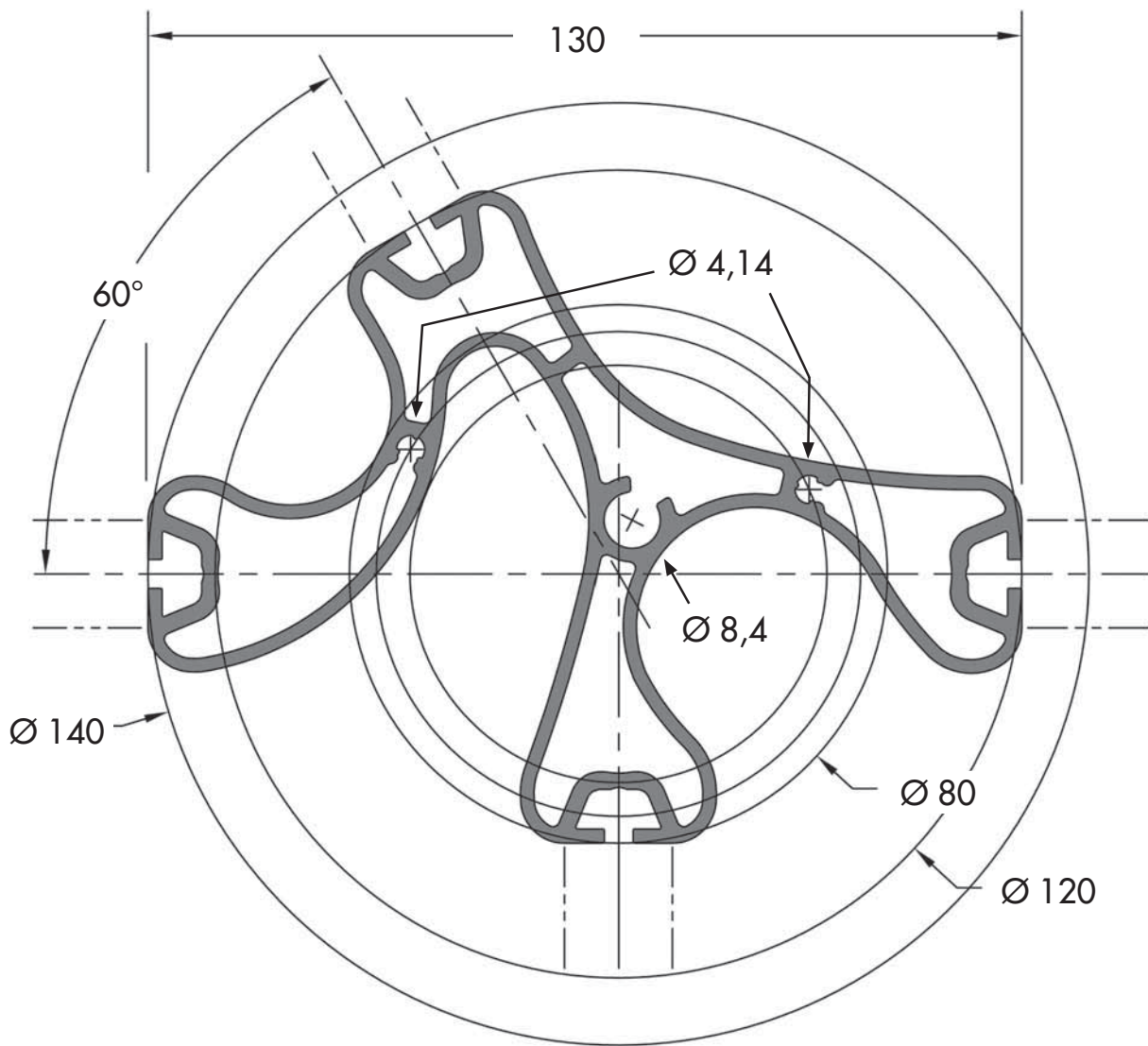

UPRIGHT EXTRUSION



Aluminium Anodized or Ral Powder Coated W: 190mm 5.3 Kg/m	6200mm cut to length	VA 4030
	1005mm tooled both ends	VA 4031
	1240mm - " - " -	VA 4032
	2010mm - " - " -	VA 4033

END PLATE

VA 1230



Steel
Grey powder coated RAL 9006
incl. fastening kit for 1-2 stacked plates
H: 5mm
0.19 Kg

END PLATE

VA 1231



Acrylic
Orange, 5130 R/R double satin
incl. fastening kit for 1-2 stacked plates
H: 5mm
0.05 Kg

END PLATE

VA 1232



Acrylic
Turquoise, 2040 R/R double satin
incl. fastening kit for 1-2 stacked plates
H: 5mm
0.05 Kg

END PLATE

VA 1233



Acrylic
Opaque, 0000 R/R double satin
incl. fastening kit for 1-2 stacked plates
H: 5mm
0.05 Kg

CONNECTING PART

VA 1239



Steel, galvanised
H: 105mm, 5mm visible
0.35 Kg



▼ **TOOLED** = Threaded for M10 bolt and deburred

ORGANIC PRODUCT LINE
EXTRUSION VA 4030

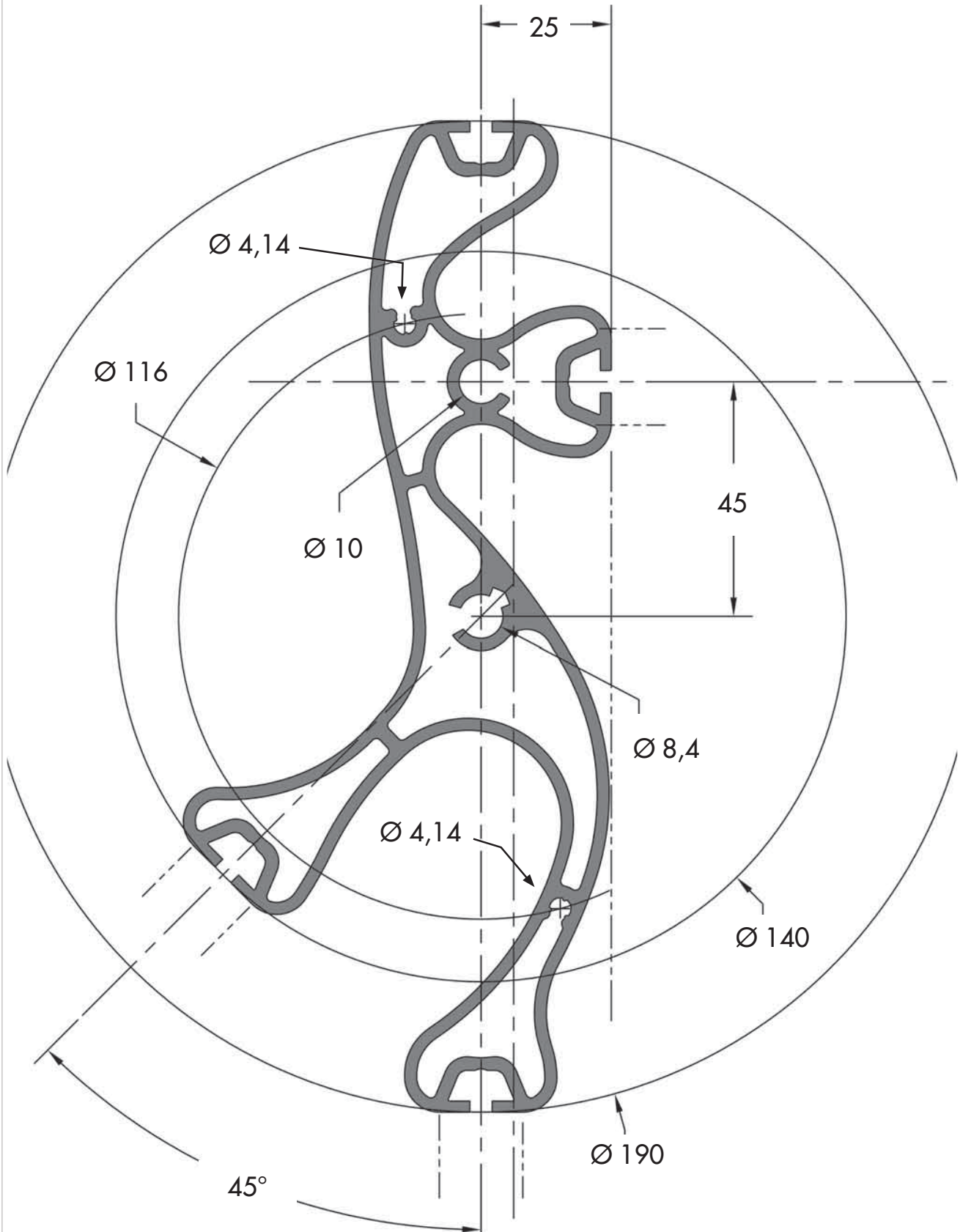

ORGANIC PRODUCT LINE



DISPLAY SHELF

VA 1211

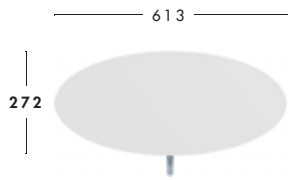

Beech core with white laminated top and bottom
Oval shaped
2.25 Kg



DISPLAY SHELF

VA 1212



Beech core with white laminated top and bottom
8 - shaped
2.25 Kg



DISPLAY SHELF

VA 1213



Beech core with white laminated top and bottom, left side
Cone shaped
0.95 Kg



DISPLAY SHELF

VA 1214



Beech core with white laminated top and bottom, right side
Cone shaped
0.95 Kg

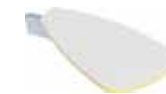

DISPLAY SHELF

VA 1215

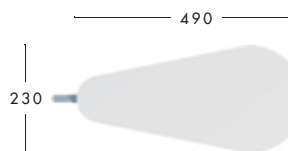

Beech core with white laminated top and bottom
Tear drop shaped
1.7 Kg



DISPLAY SHELF

VA 1216



Beech core with white laminated top and bottom, left side
Shark fin shaped
1.05 Kg



ORGANIC PRODUCT LINE

DISPLAY SHELF

VA 1217

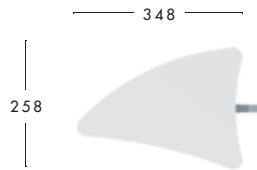

Beech core with white laminated top and bottom, right side
Shark fin shaped
1.05 Kg



END PLATE EXTENSION KIT

VA 5591

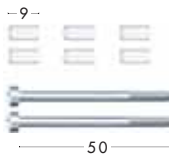

2 x M4 Bolt
with 6 distance plugs in opaque plastic
incl. allen key 3mm
for a maximum of 4 stacked end plates
L: 50mm
0.02 Kg

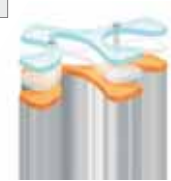

ADJUSTABLE FOOT

M 380F

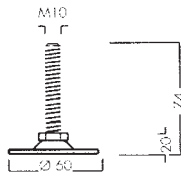

Steel
Zinc plated
Thread M10
L: 74mm
0.25 Kg

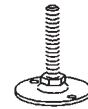

BASEPLATE FOR ORGANIC EXTRUSIONS

VA 1205



Steel
Grey powder coated RAL 9006
dia. 480mm
incl. counter sunk M10 and allen key 6mm
H: 6mm
4.0 Kg



viewpoint 1

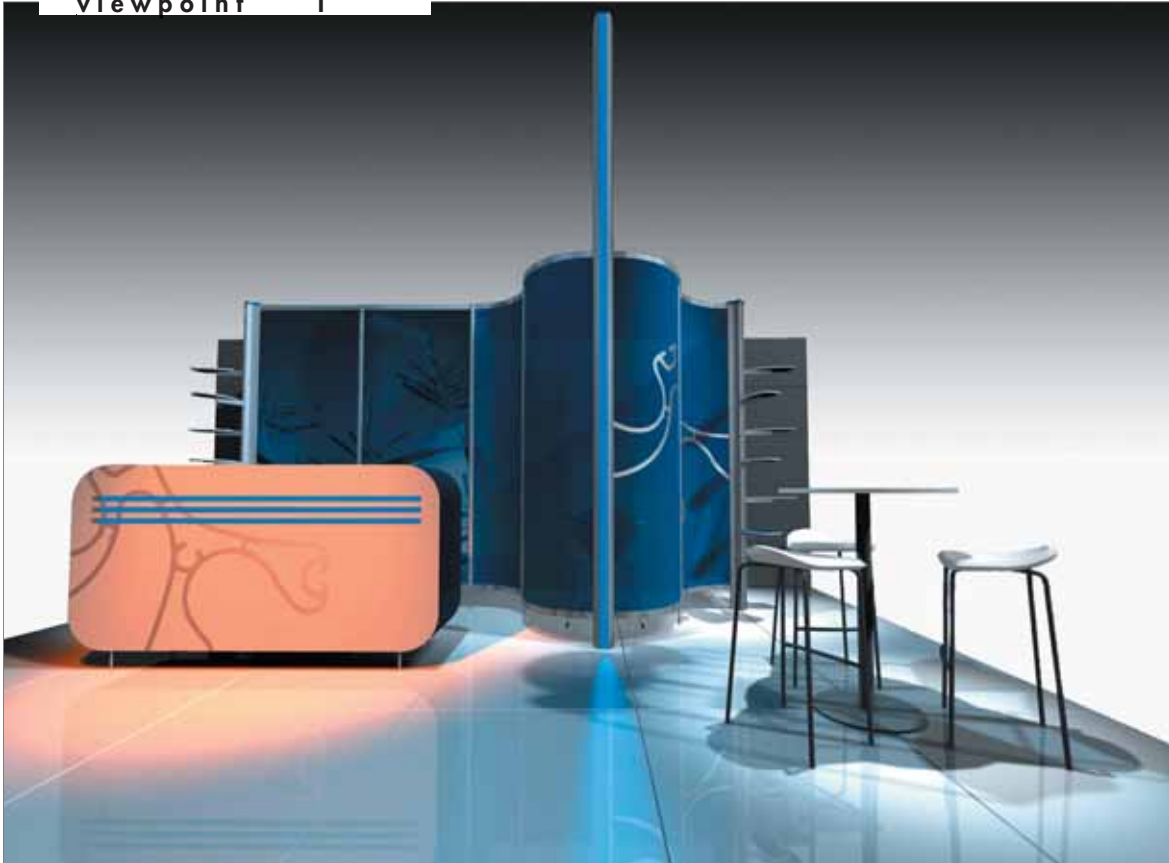

viewpoint 2



viewpoint 3



viewpoint 4



viewpoint 5

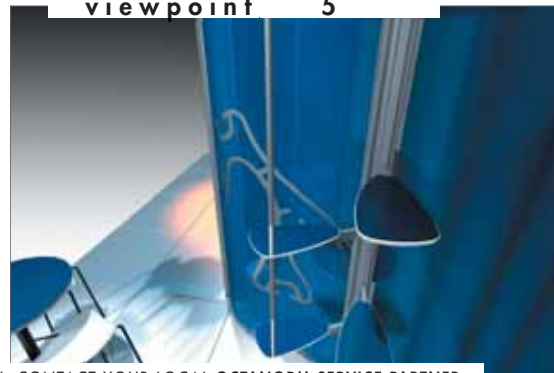

FOR MORE INFORMATION CONCERNING EXHIBITION DESIGN, CONTACT YOUR LOCAL OCTANORM SERVICE PARTNER



viewpoint 1



viewpoint 2



viewpoint 3

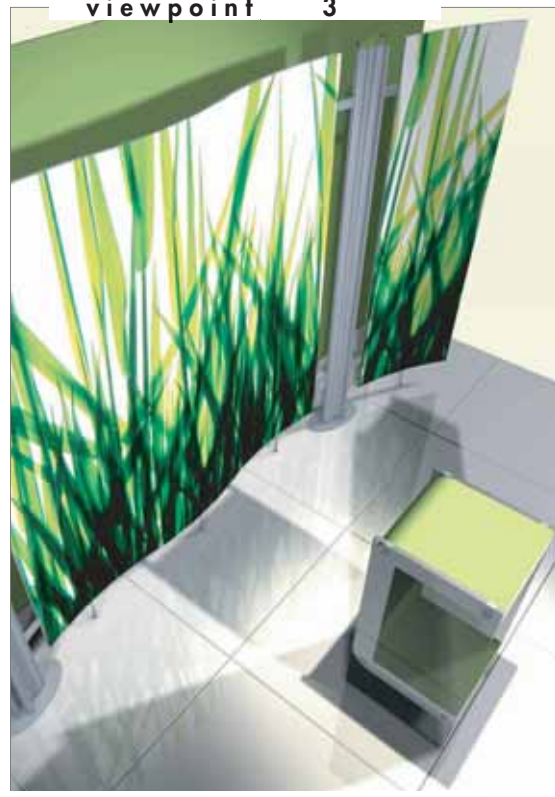

FOR MORE INFORMATION CONCERNING EXHIBITION DESIGN, CONTACT YOUR LOCAL OCTANORM SERVICE PARTNER



viewpoint 1



viewpoint 2

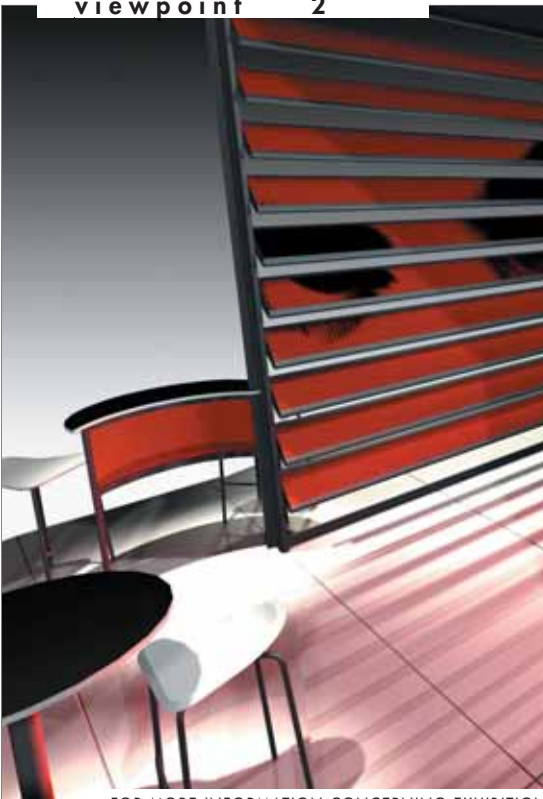

viewpoint 3



FOR MORE INFORMATION CONCERNING EXHIBITION DESIGN, CONTACT YOUR LOCAL OCTANORM SERVICE PARTNER

PLAN YOUR EXHIBITION AREA



A large grid of small dots for planning an exhibition area. The grid consists of 20 columns and 30 rows of dots, providing a space for drawing and layout design.

THE
WORLD
OF
SYSTEMS

OCTANORM 

exhibition systems
software and service